

# MPSC

# 2024

## Maharashtra Public Service Commission Assistant Engineer Examination

### Civil Engineering

### Design of Steel Structures

Well Illustrated **Theory** with  
**Solved Examples** and **Practice Questions**



**Note:** This book contains copyright subject matter to MADE EASY Publications, New Delhi. No part of this book may be reproduced, stored in a retrieval system or transmitted in any form or by any means. Violators are liable to be legally prosecuted.

# Design of Steel Structures

## Contents

UNIT	TOPIC	PAGE NO.
1.	Introduction -----	1-11
2.	Structural Fasteners & Eccentric Connections -----	12-49
3.	Tension and Compression Members -----	50-94
4.	Beams, Plate Girders and Industrial Roofs -----	95-129



# Introduction

---

## 1.1 Steel as a Structural Material

### Advantages of steel as a structural material:

- (a) As compared to other structural materials steel has high strength to weight ratio. It implies, steel possess very high strength and results in smaller sections as compared to other structural materials. Thus steel is particularly useful for carrying heavy loads with relatively small sections.
- (b) Being light, steel can be handled conveniently and thus it offers ease in transportation.
- (c) Another important property of steel is that it is ductile. Due to this very useful property it does not fail abruptly but gives ample warning by yielding before actual collapse of the structure.
- (d) Steel possess very high strength also due to which it does not undergo fracture due to large deformation and erection stresses.
- (e) Steel has a very long life when maintained properly.
- (f) Retrofitting of steel structures is quite easy as compared to other materials like RCC, timber, mortar etc.
- (g) The resale value of steel is also very high amongst all building materials. Moreover, steel can be reused also.

### Disadvantages of steel as a structural material:

- (a) Steel when placed in exposed conditions is prone to corrosion. Thus steel structures require proper protection measures to be adopted right from its manufacturing.
- (b) Steel is prone to fire and its strength reduces considerably due to high temperatures and thus steel structures require separate fire-proof treatment which ultimately adds to the cost of the structure.
- (c) Steel structures when subjected to cyclic loading (like turbo-generators of power plants etc.) and reversal of stresses undergo fatigue. This fatigue results in reduction of the strength of the steel.
- (d) Under certain conditions particularly at locations of stress concentrations, steel may lose its ductility which gets enhanced at low temperatures and under fatigue loading.
- (e) In steel construction, the designer is not having too many options as in RCC as far as size of the section is concerned. The designer is compelled to use the available standard rolled sections.

**BIS** classifies structural steel on the basis of its ultimate strength or the yield strength. The chemical composition, rolling methods, heat treatment and stress history etc. of steel determines its mechanical properties.

Some of the mechanical properties of steel are:

(a) Modulus of elasticity or Young's modulus ( $E$ )		$2 \times 10^5 \text{ N/mm}^2 = 200 \text{ kN/mm}^2$
(b) Poisson's ratio ( $\mu$ )	Elastic range	0.3
	Plastic range	0.5
(c) Shear modulus ( $G$ )		$0.77 \times 10^5 \text{ N/mm}^2 = 77 \text{ kN/mm}^2$
(d) Mass density ( $\rho$ )		$7850 \text{ kg/m}^3$
(e) Coefficient of thermal expansion ( $\alpha$ )		$12 \times 10^{-6} \text{ }^\circ\text{C}^{-1}$

## 1.2 Rolled Steel Sections

The Bureau of Indian Standards (BIS) publishes **IS Handbook No.1** that tabulates weight per unit length, geometric dimensions and other dimensions for various types of steel sections.

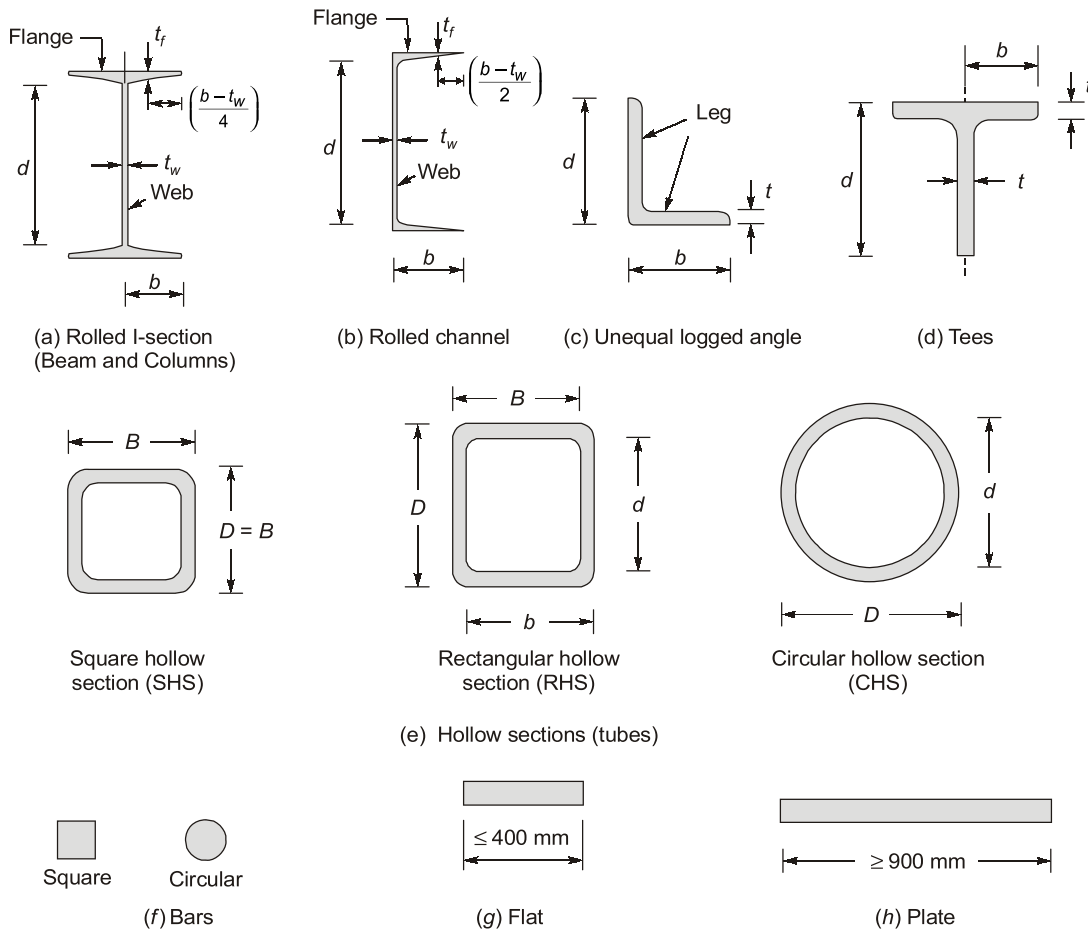

**Fig. Rolled structural steel sectional shapes**

Commonly used sections are:

- |  |  |
|--|--|
| (a) Hot rolled steel I-section <b>Fig. (a)</b>     | (b) Hot rolled steel channel section <b>Fig. (b)</b> |
| (c) Hot rolled steel angle section <b>Fig. (c)</b> | (d) Hot rolled steel tee (T) section <b>Fig. (d)</b> |
| (e) Hot rolled steel tube section <b>Fig. (e)</b>  | (f) Hot rolled steel bars <b>Fig. (f)</b>            |
| (g) Hot rolled steel flats <b>Fig. (g)</b>         | (h) Hot rolled steel plates <b>Fig. (h)</b>          |
| (i) Hot rolled steel sheets                        | (j) Hot rolled steel strips                          |

### Designation of Some Indian Standard Rolled Steel Sections

- |          |  |
|----------|--|
| (a) ISJB | : Indian Standard Junior Beam                                |
| (b) ISLB | : Indian Standard Light Beam                                 |
| (c) ISMB | : Indian Standard Medium Beam                                |
| (d) ISHB | : Indian Standard Heavy Beam (mostly used as column section) |
| (e) ISWB | : Indian Standard Wide Flange Beam                           |
| (f) ISJC | : Indian Standard Junior Channel                             |
| (g) ISLC | : Indian Standard Light Channel                              |
| (h) ISMC | : Indian Standard Medium Channel                             |
| (i) ISSC | : Indian Standard Special Channel                            |
| (j) ISJT | : Indian Standard Junior T Bar                               |
| (k) ISNT | : Indian Standard Normal T Bar                               |
| (l) ISHT | : Indian Standard Wide Flange T Bar                          |
| (m) ISST | : Indian Standard Long Legged T Bar                          |
| (n) ISLT | : Indian Standard Light T Bar                                |
| (o) ISA  | : Indian Standard Angle (both equal and unequal legged)      |
| (p) ISBA | : Indian Standard Bulb Angle                                 |
| (q) ISRO | : Indian Standard Round Bar                                  |
| (r) ISSQ | : Indian Standard Square Bar                                 |
| (s) ISPL | : Indian Standard Plate                                      |
| (t) ISF  | : Indian Standard Flat                                       |
| (u) ISSH | : Indian Standard Sheet                                      |
| (v) ISST | : Indian Standard Strip                                      |

**Note:** All standard I and channel sections have a slope of  $16\frac{2}{3}\%$  on the inner face of the flange.

### 1.3 Local Buckling

- Most of the structural sections whether hot rolled or cold rolled are made of plate elements be it channel section, angle section, T-section, I-section and so on.
- These individual plate elements are joined together to form the desired section.
- When any of these sections is subjected to compressive stresses (direct compressive stress, flexural compressive stress etc.) then stability of its component plate elements must be ensured.
- The thin plate elements may buckle locally out of their original straight plane when subjected to compressive stresses.
- Local buckling adversely affects the load carrying capacity of the section. Buckling affects the strength of section in the following ways:
  - (a) Buckling may lead to overall failure of the structure rendering the plate element to be ineffective.
  - (b) Buckling may give rise to redistribution of stresses and thus affects the load carrying capacity of the section.

The effect of local buckling of plate element on the strength of the whole structure depends on the location of buckled element, its buckling and post buckling characteristics and the type of structural member.

- For uniform compression and pure bending, the critical stress is given by,

$$f_{cr} = \frac{K\pi^2 E}{12(1-\mu^2)\left(\frac{b}{t}\right)^2} \quad \dots(1.1)$$

- For pure shear, the critical stress is given by,

$$\tau_{cr} = \frac{K\pi^2 E}{12(1-\mu^2)\left(\frac{d}{t_w}\right)^2} \quad \dots(1.2)$$

Where  $K$  = Buckling constant which depends on the support conditions and ratio of length to width of the plate.

$b$  = Width of the plate,  $t$  = Thickness of the plate

$E$  = Modulus of elasticity of steel i.e. Young's modulus,  $\mu$  = Poisson's ratio

From Eq. (1.1) and (1.2) it can be deduced that fundamentally there is no difference between the buckling phenomena as represented by these two equations. In case of pure shear, buckling takes place due to inclined compressive stress which tries to create diagonal compressive waves in the plate.

## Prevention of Local Buckling

The local buckling can be prevented by adopting a higher thickness value for the plate element. IS 800:2007 puts a limit on width to thickness ratio of component steel plates of the section as given in Table 1.1.

Limiting width-to-thickness ratio						
Compression Element		Ratio	Class of Section			
			Class 1 Plastic	Class 2 Compact	Class 3 Semi-Compact	
Outstanding element of compression flange	Rolled section	$b/t_f$	9.4ε	10.5ε	15.7ε	
	Welded section	$b/t_f$	8.4ε	9.4ε	13.6ε	
Internal element of compression flange	Comp. due to bending	$b/t_f$	29.3ε	33.5ε	42ε	
	Axial compression	$b/t_f$	Not applicable			
Web of an I-H-or box Section	Neutral axis at mid-depth	$d/t_w$	84ε	105ε	126ε	
	Generally	If $r_1$ is negative	$\frac{84ε}{1+r_1}$	$\frac{105ε}{1+r_1}$	$\frac{126ε}{1+2r_2}$ but ≤ 40ε	
		If $r_2$ is negative	but ≤ 40ε	$\frac{105ε}{1+1.5r_1}$ but ≤ 40ε		
	Axial compression		$d/t_w$	Not applicable		42ε
Web of a channel		$d/t_w$	42ε	42ε	42ε	
Angle, compression due to bending (both criteria should be satisfied)		$b/t$	9.4ε	10.5ε	15.7ε	
		$d/t$	9.4ε	10.5ε	15.7ε	
Single angle, or double angles with the components separated, axial compression (All three criteria should be satisfied)		$b/t$	Not applicable			
		$d/t$				
		$(b+d)/t$				15.7ε
Outstanding leg of an angle in contact back-to-back in a double angle member		$d/t$	9.4ε	10.5ε	15.7ε	
Outstanding leg of an angle with its back in continuous contact with another component		$d/t$	9.4ε	10.5ε	15.7ε	
Stem of a T-section, rolled or cut from a milled I or H-section		$D/t_f$	8.4ε	9.4ε	18.9ε	
Circular hollow tube, including welded tube subjected to:		$D/t$	(a) Moment	$42ε^2$	$52ε^2$	$146ε^2$
			(b) axial compression	Not applicable		$88ε^2$
Circular hollow section	Compression due to bending	$D/t$	$42ε^2$	$52ε^2$	$88ε^2$	
Mix-rolled rectangular hollow section (RHS)	Flange: compression due to bending Web: neutral axis at mid-depth Generally	$d/t$	29.3ε	33.5ε	42ε	
		$d/t$	67.1ε	84ε	125.9ε	
		$d/t$	$64ε/(1+0.6r_1)$ but < 40ε	$84ε/(1+r_1)$ but < 40ε	$125.9ε/(1+2r_1)$ but < 40ε	

$$ε = \sqrt{\frac{250}{f_y}}$$

**NOTE**

IS 800:2007 specifies no limit on minimum thickness requirement of steel sections but however a minimum thickness of 6 mm for main members and 5 mm for secondary members must be used in steel design and construction. This minimum thickness is required for better performance under adverse environmental conditions. In addition to that, steel in contact with water and soil and those subjected to alternate wetting and drying, an additional thickness of 1.5 mm should be provided.

- **Internal Elements:** These are the elements which are attached along both the longitudinal edges to other elements or to the longitudinal stiffeners connected at adequate intervals to the transverse stiffeners e.g. web of I-section and flanges and web of box section.
- **Outstand Elements:** These are also called as outstands and are attached only to one of the longitudinal edges to an adjacent element and the other edge is being free to get displaced out of its plane e.g. flange overhang of an I-section and legs of an angle section.

## 1.4 Classification of Cross-section

- The phenomenon of local buckling imposes a limit to the extent to which sections can be made thin walled.

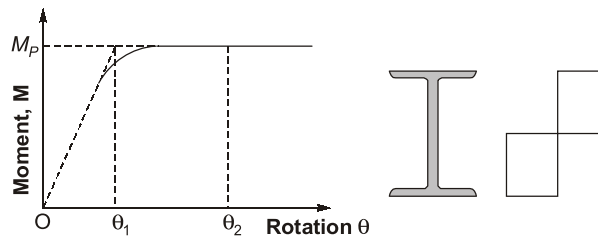

**Fig. Elastic-plastic moment rotation curve**

- The classification of cross-sections is done on the basis of moment rotation characteristics as shown in **Fig.** assuming that the flange or web plate does not buckle locally.

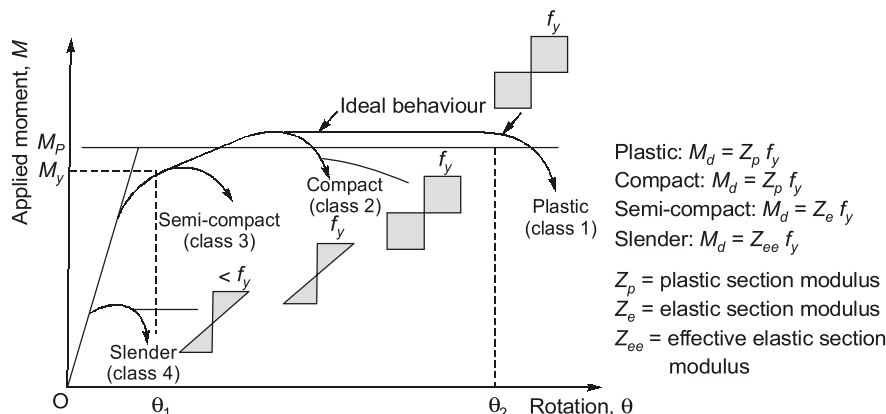

**Fig. Moment rotation characteristics of four classes of cross section**

- It is essential to classify sections on the basis of their tendency to buckle locally before overall failure of member takes place.



### Basis of Section Classification

- (a) The plate elements of the cross section being thin may buckle locally about their weak axis especially due to compressive stresses. This local buckling can be avoided before a limit state is reached by limiting the width to thickness ratio of each element of the cross section subjected to compressive load, moment and shear.
- (b) When plastic analysis is used, members must be capable of forming the plastic hinges with sufficient rotation capacity (i.e. ductility) without local buckling to enable the redistribution of bending moment required before formation of failure mechanism.
- (c) When elastic analysis is used, the member must be capable of developing the yield stress under compression without undergoing local buckling.

Based on these considerations, four classes of sections are mentioned in **Table**.

Table Cross-section classification and their characteristics		
S.No.	Types of Sections	Characteristics
1.	Plastic (Class 1)	<ul style="list-style-type: none"> <li>● Cross sections, which can develop plastic hinges and have the rotation capacity required for failure of the structure by formation of a plastic mechanism, are called plastic sections. These sections are used in plastic analysis and design.</li> <li>● These sections are used in indeterminate frames forming plastic collapse mechanism.</li> <li>● The stress distribution for these sections is rectangular.</li> </ul>
2.	Compact (Class 2)	<ul style="list-style-type: none"> <li>● Cross sections, which can develop plastic moment of resistance, but have inadequate plastic hinge rotation capacity for formation of a plastic mechanism before buckling are referred to as compact sections.</li> <li>● These cross sections may develop full plastic stress distribution across the entire cross-section but do not have adequate ductility.</li> <li>● For a section to be compact, its compression elements must have width-to-thickness ratios equal to or less than the limiting values given in Table 1.1. These can be used for all the structural elements.</li> <li>● The stress distribution for these sections is rectangular.</li> </ul>
3	Semi-compact (Class 3)	<ul style="list-style-type: none"> <li>● Cross sections, in which the extreme fiber in compression can reach yield stress (assuming an elastic distribution of stress), but cannot develop the plastic moment of resistance due to local buckling are referred to as semi-compact sections.</li> <li>● The yield stress reaches only in some parts of compression elements before buckling occurs.</li> <li>● It is not capable of reaching a fully plastic stress distribution.</li> <li>● These sections are used in elastic design. The stress distribution for such sections is triangular.</li> </ul>
4.	Slender (Class 4)	<ul style="list-style-type: none"> <li>● Cross sections, in which the elements buckle locally even before the attainment of yield stress are classed as slender sections.</li> <li>● These sections are used in cold-formed members and do not comply with the requirements of Table 1.1.</li> <li>● The effective section for design should be calculated by deducting width of compression plate element in excess of the semi-compact section limit.</li> </ul>

### 1.5 Modes of Failure in Beam

- (a) **Bending:** The gravity loading gives rise to bending of beam. This causes longitudinal stresses to be developed in the beam. As the bending moment increases, these flexural stresses increase further till they reach yield stress. At certain point, either the steel yields in tension and/or yields in compression. At this stage of loading, the beam section becomes plastic, fails by formation of a plastic hinge at the location of maximum moment being induced by the loading. **Fig. 1.5** shows the various stages in a beam bending till failure.

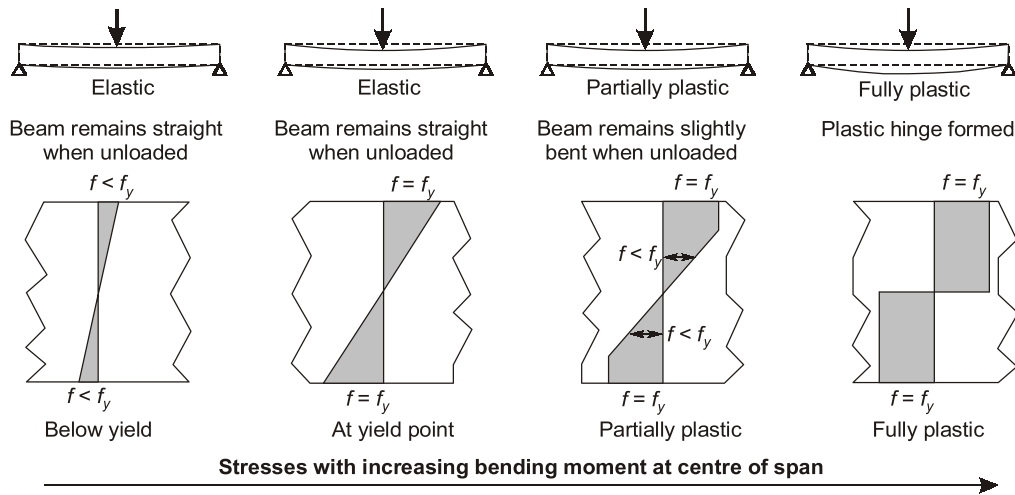

**Fig. Various stages of beam bending failure**

(b) **Local buckling:** During the bending process, if the compression flange or a part of the web subjected to compression is too thin to take any appreciable amount of compression then the plate may fail due to buckling (or rippling) even before the full plastic moment is reached.

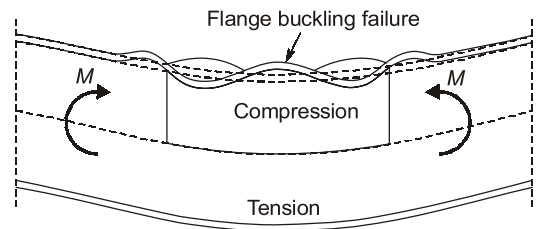

**Fig. Local flange buckling failure**

(c) **Shear:** Generally in portions near to the supports, very large shear exists. In this case the beam may fail in shear if the web is not of sufficient thickness. Formation of plastic hinges accompanies this process as shown in **Figure (a)**.

(d) **Shear buckling:** During the shearing process, if the web is too thin then it is prone to get fail by buckling (or rippling) as shown in **Figure (b) & (c)**.

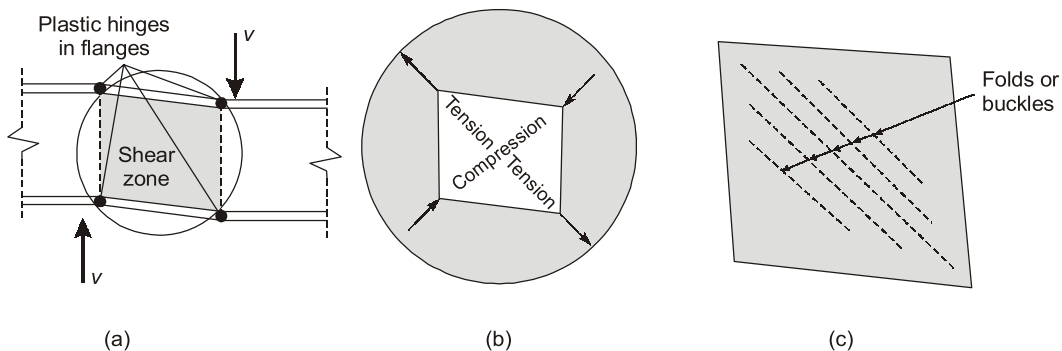

**Fig. Shear and shear buckling failure (a) shear failure, (b) shear buckling**

(e) **Web crushing and buckling:** Because very high vertical stresses act on supports and at location of point loads, the beam web may get fail by crushing or buckling as shown in **Figure**.

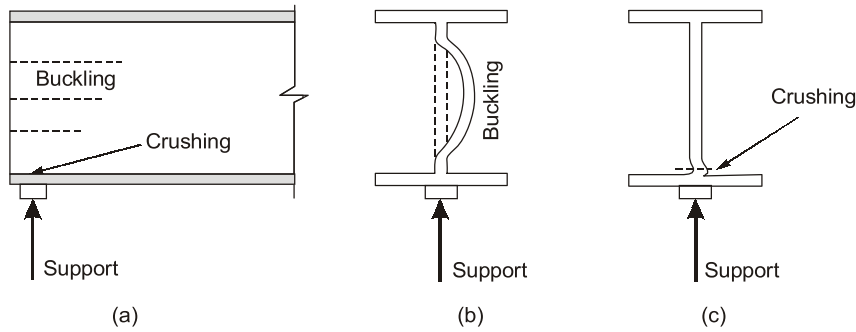

**Fig. Web buckling and web bearing failures**

(f) **Lateral torsional buckling:** This type of failure occurs when the beam has high flexural stiffness in the vertical plane (i.e. in the direction of gravity) as compared to the horizontal plane. The beam has a tendency to deflect sideways.

- For example, a loaded cantilever as shown in Fig. will deflect and twist in the sideways direction. When this beam is prevented from deflecting sideways by a floor/slab construction, the beam is torsionally restrained. It is essential to check the stability of beam in the lateral direction also. A nominal amount of torsional restraint is assumed to exist when web of the beam is connected through cleat angles, end plates etc. as shown in Fig.

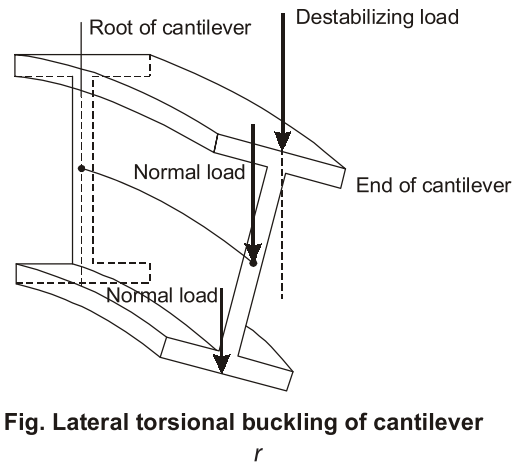

**Fig. Lateral torsional buckling of cantilever**

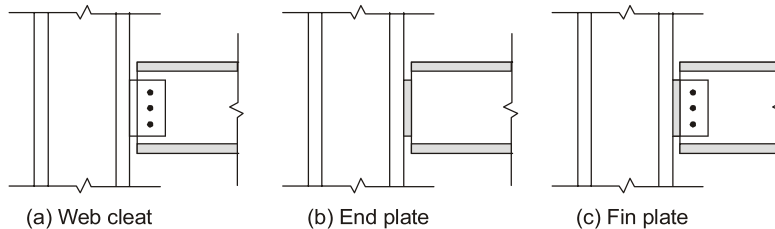

**Fig. Nominal torsional restraint at beam support supplied by (a) web cleats (b) end plate (c) fin plate**

(g) **Deflection:** It is quite practical that a beam may not get fail due to excessive deflection but on the other hand too much deflection can lead to discomfort to the occupants along with stripping off of flooring, finishes etc.

## 1.6 Design of Steel Structures

- Errors and uncertainties get involved in precisely assessing the probable loads that will act on the structure and the structural behavior of the materials.
- The various structural design requirement criteria relate to corresponding limit states and thus the design of structure to comply with all the essential requirements may be called as limit state of design.
- There are two design criteria viz. the **strength design criteria** and the **stiffness design criteria**.

### Strength Design Criteria

- These are related to possible modes of failure of a structure due to over loading and/or understrength conditions.

- These design criteria are concerned with yielding, buckling, fatigue, brittle fracture corrosion.
- The major design philosophies under these criteria are the **working stress method**, **ultimate load method** and the **limit state method**.

### Stiffness Design Criteria

- These design criteria are related to serviceability of the structure under working loads and are prominently concerned with ensuring that structure has sufficient stiffness that may otherwise lead to excessive deformations including deflections, distortion, sagging etc.

## 1.7 Limit State Design

- In the limit state design of structures, all conditions are taken into account that makes the structure unfit for use.
- This limit state method of design considers all the relevant conditions pertaining to limit states of strength and serviceability.
- The strength limit states are based on load carrying capacity of the structure which includes buckling, fatigue, fracture etc. Serviceability limit states are based on performance of the structure under the actual application of service loads and includes deflection, vibration, corrosion, ponding etc.
- The loads at working conditions are factored by the use of partial safety factors for loads resulting in factored loads/design loads.
- The normal strength of the material is called as its ultimate capacity and the corresponding design strength of the material is obtained by dividing the ultimate capacity with the partial safety factor. Thus the member so designed must meet the basic criteria as

$$\text{Design action} \leq \text{Design strength}$$

**Note:** The section designed must satisfy the serviceability criteria over and above the strength criteria.

### Advantages of Limit State Design

- (a) This method recognizes that design parameters are variants.
- (b) This method logically deals with the fact that there exists always a possibility of variations in loads and material properties.
- (c) This method gives different weightages to different loads and materials

### Disadvantages of Limit State Design

- There is a likelihood of design errors because of more complex theory which are not so in the working stress method of design.
- Limit state method of design is far better than other design philosophies.

**NOTE:** IS 800 : 2007 is the design code for the structures which is based on limit state method of design however it still maintains the working stress design approach.

### Design Load

- The design load in LSM of design is obtained by multiplying the working load (called as **characteristic load**) with a partial factor of safety and the resulting load is called as **factored load** or the **design load**. Different design loads (i.e. dead load, live load, wind load, earthquake load etc.) are then combined under the most severe but realistic conditions.

### Design Strength

- The design strength of the material is obtained by dividing the characteristic strength of the material by a suitable partial factor of safety.
- The design strength of each material (and their connections) must be such that the most severe combination of design loads must not cause failure.
- It must also be ensured that the structure is stable against overturning, sway etc.

**Example 1.1** Assuming Fe410 steel, classify the following sections:

(a) ISLB 350 @ 472 N/m (b) ISHB 400 @ 806 N/m (c) ISMB 450 @ 710 N/m (d) ISA 80 × 80 × 8

**Solution:**

For Fe410  $f_u = 410 \text{ N/mm}^2, f_y = 250 \text{ N/mm}^2$

(a) ISLB 350 @ 472 N/m

$b_f = 165 \text{ mm}, t_f = 11.4 \text{ mm}, h_1 = 288.3 \text{ mm}, t_w = 7.4 \text{ mm}$

$$\epsilon = \sqrt{\frac{250}{f_y}} = \sqrt{\frac{250}{250}} = 1$$

$$\frac{b/2}{t_f} = \frac{165/2}{11.4} = 7.24 < 9.4\epsilon$$

$$\frac{h_1}{t_w} = \frac{288.3}{7.4} = 38.96 < 84\epsilon$$

Thus the section is plastic.

(b) ISHB 400 @ 806 N/m

$b_f = 250 \text{ mm}, t_f = 12.7 \text{ mm}, h_1 = 340.1 \text{ mm}, t_w = 10.6 \text{ mm}$

$$\frac{b/2}{t_f} = \frac{250/2}{12.7} = 9.84 < 10.5\epsilon$$

$$> 9.4\epsilon$$

Thus flange is compact.

$$\frac{h_1}{t_w} = \frac{340.1}{10.6} = 32.085 < 84\epsilon$$

Thus web is plastic.

Thus section is compact since among plastic and compact sections, compact section is critical.

(c) ISMB 450 @ 710 N/m

$b_f = 150 \text{ mm}, t_f = 17.4 \text{ mm}, t_w = 9.4 \text{ mm}, h_1 = 379.2 \text{ mm}$

$$\frac{b/2}{t_f} = \frac{150/2}{17.4} = 4.31 < 9.4\epsilon$$

Thus flange is plastic.

$$\frac{h_1}{t_w} = \frac{379.2}{9.4} = 40.34 < 84\epsilon$$

Thus web is plastic.

Thus section is plastic.

(d) ISA 80 × 80 × 8

$b = 80 \text{ mm}, d = 80 \text{ mm}, t = 8 \text{ mm}$

$$\frac{b}{t} = \frac{80}{8} = 10 < 10.5\epsilon \quad ; \quad \frac{d}{t} = \frac{80}{8} = 10 < 10.5\epsilon \quad ; \quad \frac{(b+d)}{t} = \frac{80+80}{8} = 20 < 25\epsilon$$

Thus section is compact.

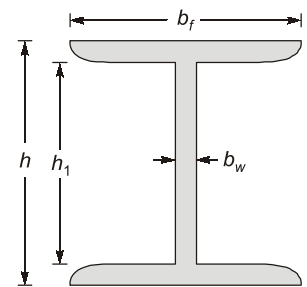

Thus flange is plastic.

Thus web is plastic.

